

L: Internal lobe type pump range



Materials: **CI** | **CS** | **SS**

L: A Style: High viscosity pumps

The LA range is the 3:4 rotor pump which is typically used for higher viscosity fluids running at reduced speed through gearboxes. These pumps are classically used in the sugar industry, but have many other applications. These pumps have a replaceable liner and all other components are designed for maximum efficiency and total life cost. There are versions of these pumps available that work on a faster running concept that gives better flow rates. The pumps can be partially cleaned via an inspection cover. Internal or external bearing options are available for this range.

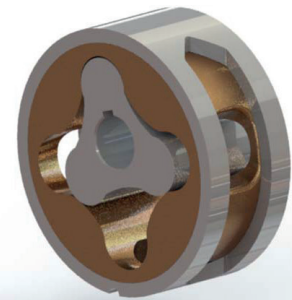

L: B Style: Low viscosity pumps

The LB range uses 7:8 for pumping chocolate and other such liquids often at higher pressures. The pumps have a low NPIP requirement and are faster running than the LA style. Internal or external bearing options are available for this range.

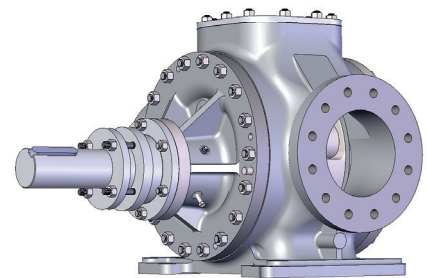

Albany's 24-page brochure is available as a download at www.albany-pumps.co.uk



AL Aluminium | CS Cast Steel | CI Cast Iron | GM Gunmetal | HY Hastelloy | NR Ni-resist | NY Nylon | PP Polypropylene | SD Super Duplex | SS Stainless Steel
 General and Chemical | Bitumen | Fire | Dispenser Machines | Food Industry | Lubrication | Marine | Oil & Gas | Refrigeration | Sugar

www.albany-pumps.co.uk +44 (0) 1594 842 275

Head Office and Manufacturing Centre

Albany Engineering Company Ltd
Church Road, Lydney
Gloucestershire, GL15 5EQ
United Kingdom

t: +44 (0) 1594 842 275
Head Office Option 1

e: salesdept@albany-pumps.co.uk

Service and Repair Centre

Albany Engineering Company Ltd
Richter Works, Garnett Street
Bradford BD3 9HB
United Kingdom

t: +44 (0) 1594 842 275
Service and Repair (Option 2).

e: servicedept@albany-pumps.co.uk

L: A and B Style Internal lobe pumps:

Albany Pumps manufacture and supply the well respected and long established range of rotary lobe pumps originally designed and manufactured by Stothert & Pitt. The product has been used in demanding applications in industries such as oil refining, sugar, paint, soap and the production of man made fibres for over 75 years.

CONSTRUCTION

Lobe pumps consist of a pump casing fitted with a renewable liner, an inner and outer rotor and a rotor shaft supported in bearings. The inner and outer rotors are mounted eccentrically to one another. The pumps can be fitted with an integral, full bore, relief valve. If this is not required, the valve facing can be blanked off and a separate relief valve supplied.

DESIGN AVAILABILITY

- LA 3:4 Rotors
- LB 7:8 Rotors
- Internal bearing
- External bearing
- Jacketed body for steam or oil heating
- Fully jacketed: covers for steam, oil or electric heating
- Vertical
- Horizontal
- Reversing flow
- Bush bearing
- Ball bearing

Handing can be arranged to suit installation requirements.



MATERIALS

The lobe pumps can be manufactured in various combinations of materials including cast iron, cast steel, aluminium bronze, phosphor bronze, stainless steel etc.

LA 3:4 Lobe pump

Designed for use on high viscosity liquids these pumps operate at low rotational speeds ensuring that the pockets created during pump rotation are completely filled.

LB 7:8 Lobe pump

Designed for use on lower viscosity liquids these pumps operate at synchronous motor speeds which allow the smaller pockets created during pump rotation to completely fill.

PERFORMANCE

Large capacity Rotary pumps for highly viscous liquids. Based on 2500 cst our LA 3:4 pump offers:

70 – 110 m3/hr	Model 6 – 12	8" Branch
120 – 150 m3/hr	Model 8 – 12	12" Branch
160 – 200 m3/hr	Model 8 – 16	12" Branch
250 – 350 m3/hr	Model 11 – 18	14" Branch

Maximum pressure: 25 barg. Maximum viscosity 250,000 centistokes.

LB 7:8 stylee for liquids of 2000 centistokes maximum.

at 720 rpm: maximum flow 103 m3/hr

at 960 rpm: maximum flow 120 m3/hr

Albany Pumps

L: A and B Style Internal lobe pumps:

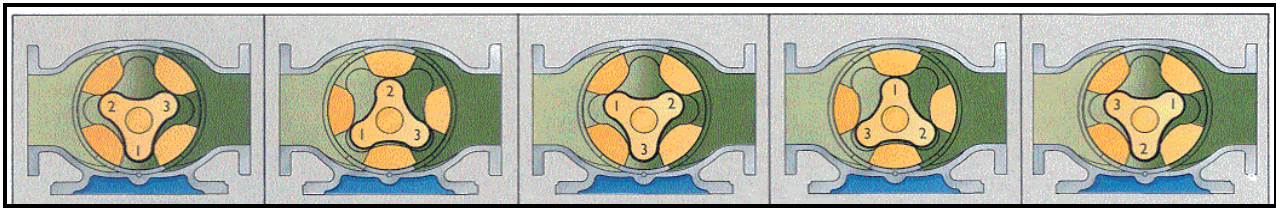

LA 3:4 Pump, operational cycle

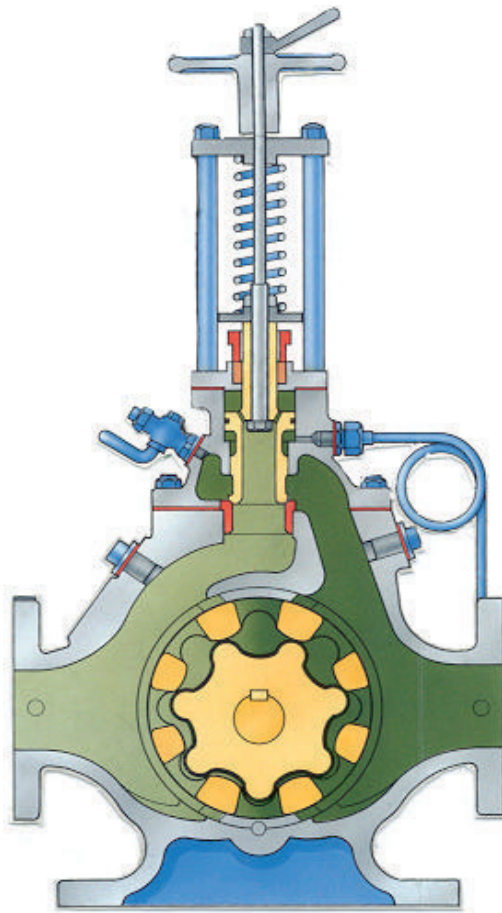

7:8 Pump with Relief Valve

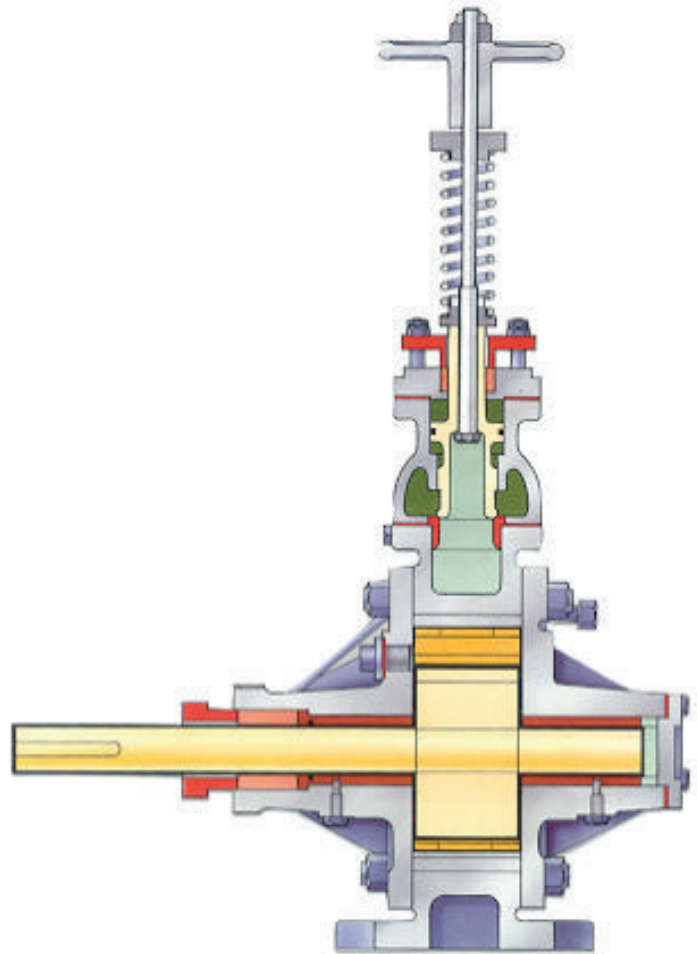

LB 7:8 Pump with Relief Valve

L: A and B Style Internal lobe pumps:

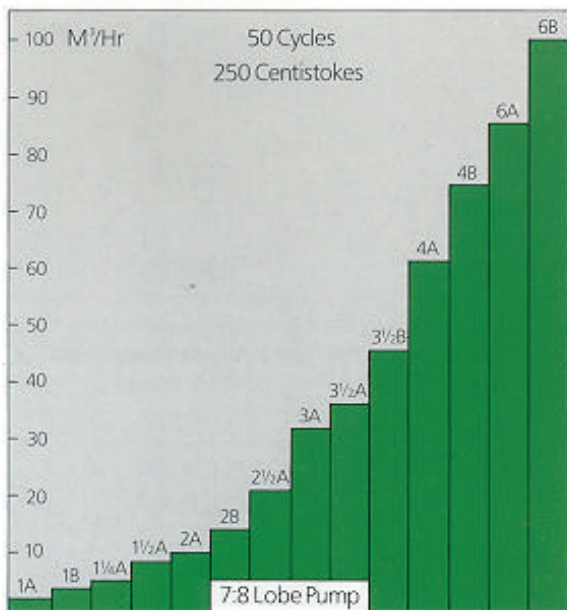

PUMPING ACTION

The inner and outer rotors are mounted eccentrically to one another. The principal of operation is shown in the diagram which shows one full rotation of a LA3:4 pump.

PERFORMANCE

- | | | |
|--------|-----------------|------------------------|
| LA 3:4 | Capacity Range: | - 0.3 - 350 m³/hr |
| | Pressure: | - Up to 25 bar |
| | Viscosity: | - 1500c/s - 250,000c/s |
| LB 7:8 | Capacity Range: | - 1 - 100 m³/hr |
| | Pressure: | - Up to 20 Bar |
| | Viscosity: | - 10c/s - 2,000 c/s |

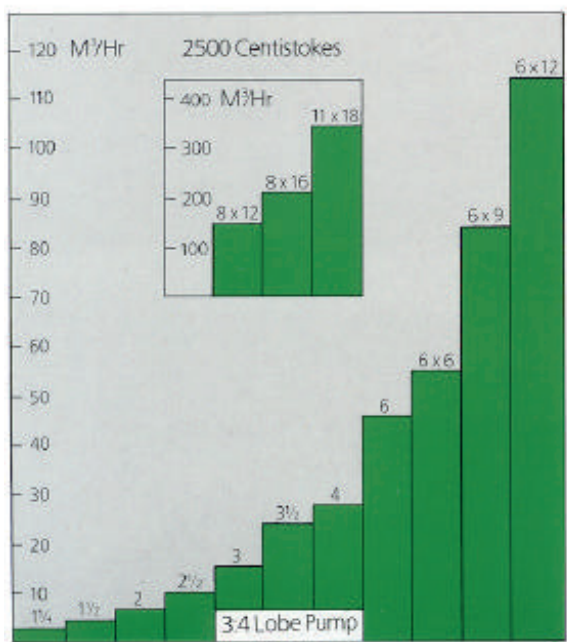

DRIVE ARRANGEMENT

For normal applications:

LA 3:4 pumps normally run at slow speeds with a gearbox or other forms of speed reducer between the prime mover and the pump.

LB 7:8 pumps run at synchronous speed, 4 pole speeds are used on smaller pumps while 6, 8 or 10 pole speeds are used on the large pumps.

L: A and B Style Internal lobe pumps:

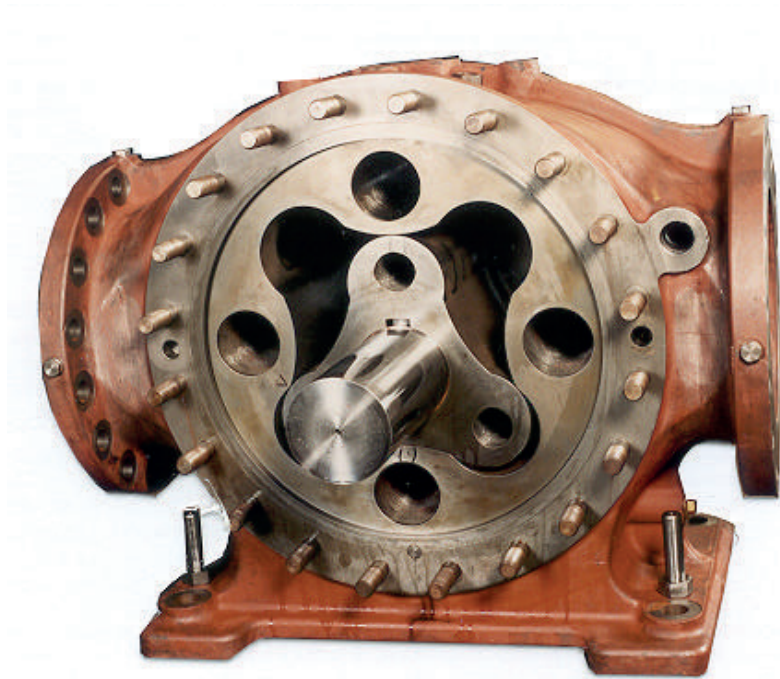

Applications:

Molasses Docks Cargo unloading and loading to 350 m³/hr

Road tankers

Sugar factories

Viscous fuel oils:

Jacketed pumps:

Corrosive duties:

Vertical Immersed pumps for bitumen and asphalt

power station duties
high capacity cargo pumps

Resins, glues/adhesives

Albany rotary lobe pumps are produced in gunmetal and stainless steel

SERVICE AND SPARE PARTS

All Albany Lobe pumps are fully guaranteed.

Maintenance can normally be carried out without disconnecting either the suction or delivery pipework and with the electric motor remaining in situ if required.

Albany have a Spares & Service Department to cover any service work which may be required after expiry of warranty. Service contracts can be arranged which allow periodic pump inspection and reporting